

GV3L50

TeSys GV3 Manual Starter and Protector,
magnetic circuit protector, rotary handle, 50 A,
EverLink BTR connectors

Product availability : Non-Stock - Not normally stocked in distribution facility



Price* : 454.00 USD



Main

Range	TeSys
Product name	TeSys GV3
Device short name	GV3L
Device application	Motor
Poles description	3P
Network type	AC
Utilisation category	Category A IEC 60947-2 AC-3 IEC 60947-4-1
Network frequency	50/60 Hz
Breaking capacity	100 kA Icu 230/240 V AC 50/60 Hz 50 kA Icu 440 V AC 50/60 Hz 12 kA Icu 500 V AC 50/60 Hz 6 kA Icu 690 V AC 50/60 Hz 50 kA Icu 400/415 V AC 50/60 Hz
[Ics] rated service short-circuit breaking capacity	100 % 230/240 V AC 50/60 Hz 100 % 400/415 V AC 50/60 Hz 100 % 440 V AC 50/60 Hz 50 % 500 V AC 50/60 Hz 50 % 690 V AC 50/60 Hz
Trip unit technology	Magnetic
Magnetic tripping current	700 A

Complementary

Fixing mode	35 mm symmetrical DIN rail clipped Panel screwed with 3 x M4 screws)
Operating position	Any position
Motor power kW	22 kW 400/415 V AC 50/60 Hz

* Price is "List Price" and may be subject to a trade discount – check with your local distributor or retailer for actual price.

Oct 2, 2020

	30 kW 500 V AC 50/60 Hz 45 kW 690 V AC 50/60 Hz
Control type	Rotary knob
[Ue] rated operational voltage	690 V AC 50/60 Hz IEC 60947-2
[Ui] rated insulation voltage	690 V AC 50/60 Hz IEC 60947-2
[Uimp] rated impulse withstand voltage	6 kV IEC 60947-2
Mechanical durability	50000 cycles
Electrical durability	50000 cycles AC-3 415 V
Maximum operating rate	25 cyc/h
Connections - terminals	EverLink BTR screw connectors 1 0.00...0.05 in ² (1...35 mm ²) solid EverLink BTR screw connectors 2 0.00...0.04 in ² (1...25 mm ²) solid EverLink BTR screw connectors 1 0.00...0.05 in ² (1...35 mm ²) flexible without cable end EverLink BTR screw connectors 2 0.00...0.04 in ² (1...25 mm ²) flexible without cable end EverLink BTR screw connectors 1 0.00...0.05 in ² (1...35 mm ²) flexible with cable end EverLink BTR screw connectors 2 0.00...0.04 in ² (1...25 mm ²) flexible with cable end
Tightening torque	44.25 lbf.in (5 N.m) EverLink BTR screw connectors 0.04 in ² (25 mm ²) 70.81 lbf.in (8 N.m) EverLink BTR screw connectors 0.05 in ² (35 mm ²)
Mechanical robustness	Shocks 15 Gn for 11 ms closed IEC 60068-2-27 Shocks 30 Gn for 11 ms opened IEC 60068-2-27 Vibrations 4 Gn, 5...300 Hz IEC 60068-2-6
Suitability for isolation	Yes IEC 60947-1
Maximum Height	5.20 in (132 mm)
Maximum Width	2.17 in (55 mm)
Maximum Depth	5.35 in (136 mm)
Net Weight	2.12 lb(US) (0.96 kg)

Environment

Standards	EN/IEC 60947-2 EN/IEC 60947-4-1 CSA C22.2 No 60947-4-1 UL 60947-4-1
Product certifications	IECEE CB Scheme UL CSA CCC EAC ABS LROS (Lloyds register of shipping) DNV-GL BV
Protective treatment	TH
IP degree of protection	IP20 IEC 60529
IK degree of protection	IK09
Ambient air temperature for operation	-4...140 °F (-20...60 °C)
Ambient air temperature for storage	-40...176 °F (-40...80 °C)
Fire resistance	1760 °F (960 °C) IEC 60695-2-1
Operating altitude	0...9842.52 ft (0...3000 m)

Ordering and shipping details

Category	22366 - MAN STR PROTECTORS-GV1/GV3
Discount Schedule	I11
GTIN	00785901577003
Nbr. of units in pkg.	1
Package weight(Lbs)	2.21 lb(US) (1.00 kg)
Returnability	No
Country of origin	FR

Packing Units

Unit Type of Package 1	PCE
Package 1 Height	2.56 in (6.5 cm)
Package 1 width	5.71 in (14.5 cm)
Package 1 Length	6.30 in (16 cm)
Unit Type of Package 2	P06
Number of Units in Package 2	60
Package 2 Weight	161.07 lb(US) (73.06 kg)
Package 2 Height	31.50 in (80 cm)
Package 2 width	31.50 in (80 cm)
Package 2 Length	23.62 in (60 cm)

Offer Sustainability

Sustainable offer status	Green Premium product
California proposition 65	WARNING: This product can expose you to chemicals including: Antimony oxide & Antimony trioxide which is known to the State of California to cause Carcinogen harm. For more information go to www.p65warnings.ca.gov
EU RoHS Directive	Compliant EU RoHS Declaration
Mercury free	Yes
RoHS exemption information	Yes
China RoHS Regulation	China RoHS declaration Product out of China RoHS scope. Substance declaration for your information.
Environmental Disclosure	Product Environmental Profile
WEEE	The product must be disposed on European Union markets following specific waste collection and never end up in rubbish bins.

Contractual warranty

Warranty	18 months
----------	-----------

Tripping Curves for GV3L Combined with Thermal Overload Relay LRD33

Average Operating time at 20 °C without Prior Current Flow

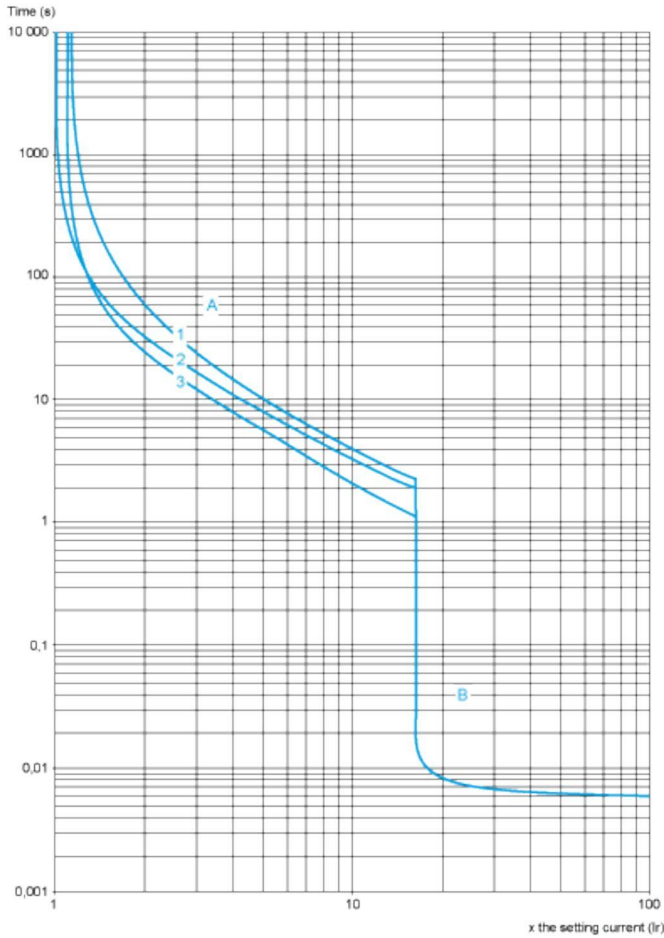

- 1 3 poles from cold state
- 2 2 poles from cold state
- 3 3 poles from hot state
- A Thermal overload relay protection zone
- B GV3L protection zone

Current Limitation on Short-Circuit for GV3L (3-Phase 400/415 V)

Dynamic Stress

$I_{peak} = f$ (prospective I_{sc}) at $1.05 U_e = 435 V$

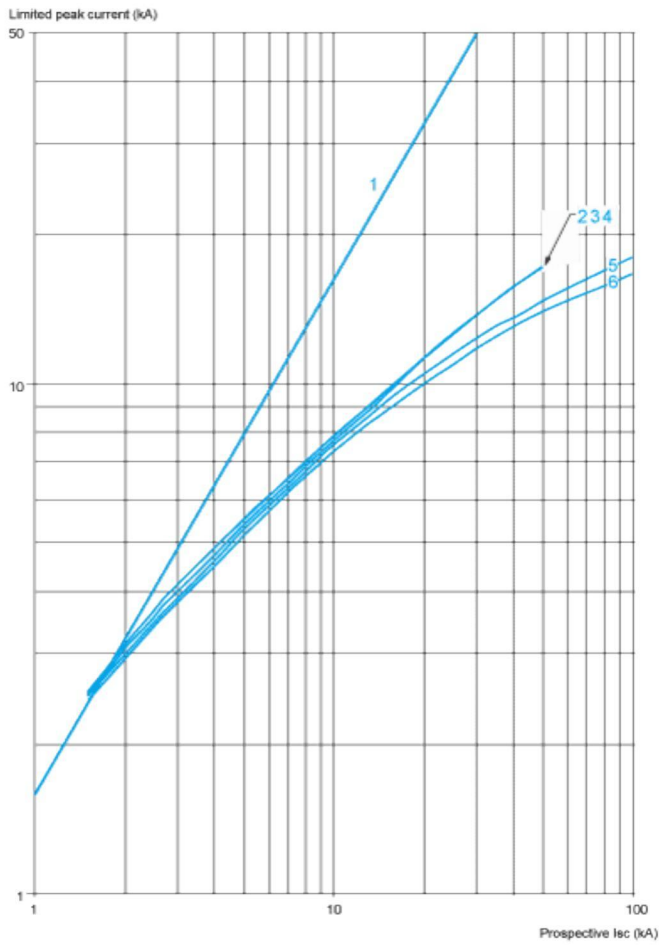

- 1 Maximum peak current
- 2 GV3L80 - GV3L73 - GV3L65
- 3 GV3L50
- 4 GV3L40
- 5 GV3L32
- 6 GV3L25

Thermal Limit on Short-Circuit for GV3L

Thermal Limit in A^2s

Sum of $I^2dt = f$ (prospective Isc) at 1.05 $U_e = 435 V$

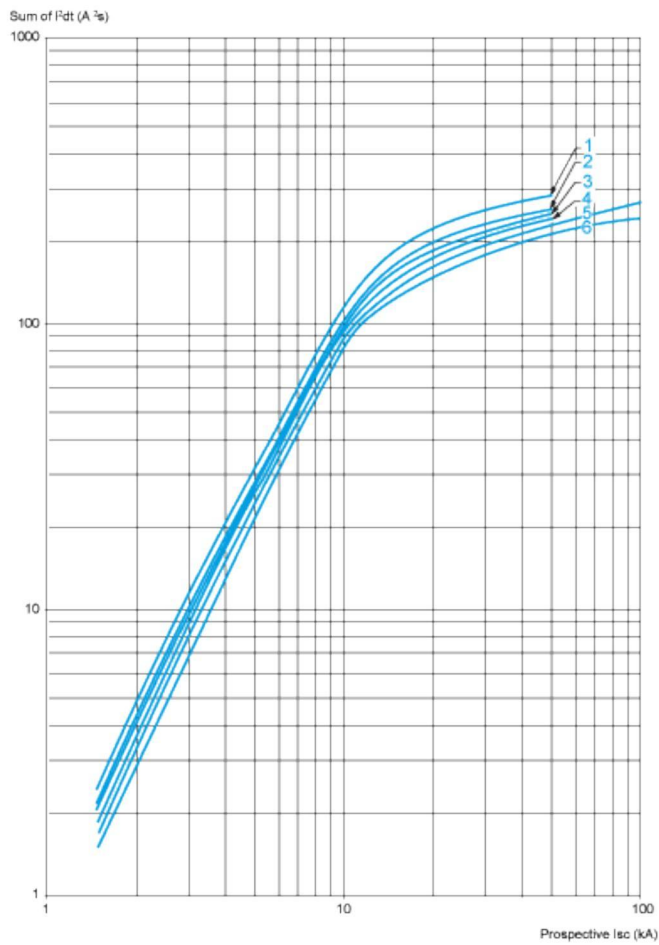

- 1 GV3L73 - GV3L80
- 2 GV3L65
- 3 GV3L50
- 4 GV3L40
- 5 GV3L32
- 6 GV3L25

GV3L, GV3P

Dimensions

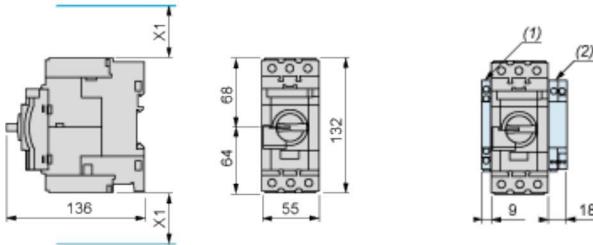

- (1) Blocks GVAN... , GVAD... and GVAM11.
- (2) Blocks GV3AU... and GV3AS... .

X1 = Electrical clearance (ISC max) 40 mm for $U_e \leq 500$ V, 50 mm for $U_e \leq 690$ V

NOTE: Leave a space of 9 mm between 2 circuit breakers: either an empty space or side-mounting add-on contact blocks. Side by side mounting is possible up to 40 °C.

Mounting with Tesys contactor LC1D40A...D80A and relay LR3D313...380 ^{(1) (2) (3)}

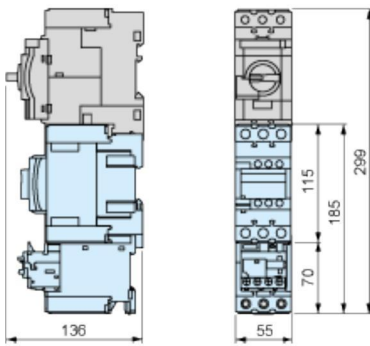

- (1) Mountings with c.b. up to GV3L73, GV3P73.
- (2) For GV3L80, GV3P80 use cable between components for dissipating heat. Consult online datasheets for values.
- (3) S-shape busbar system suitable up to 73 A.

Side by side mounting with Tesys contactor LC1D40A...D73A (S-shape busbar system GV3S⁽¹⁾)

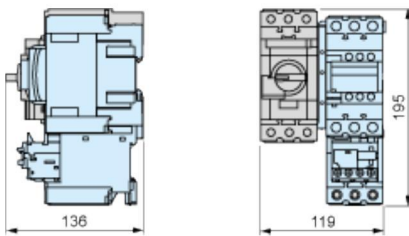

- (1) Mountings with c.b. up to GV3L73, GV3P73.

Mounting on Rail AM1 DE200 or AM1 ED201

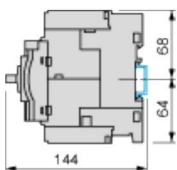

Panel Mounting, using M4 Screws

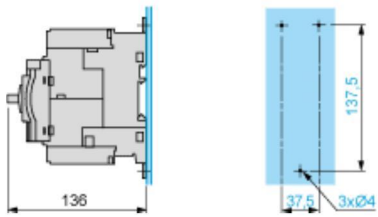

Mounting on Pre-Slotted Plate AM1 PA

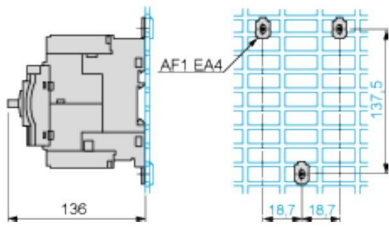

Mounting of External Operator GV3APN01, GV3APN02 or GV3APN04 for Motor Circuit Breakers GV3L

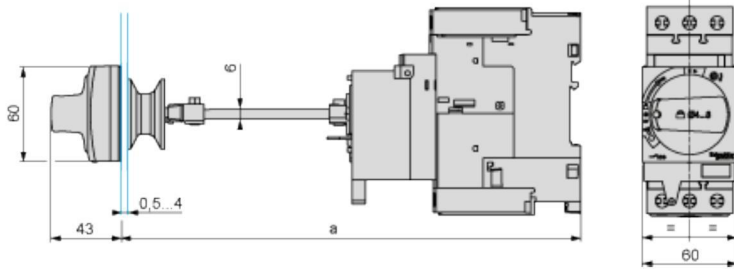

Door cut-out

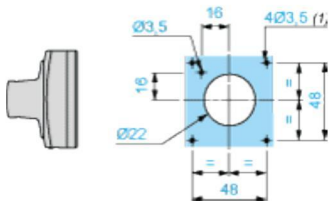

(1) For IP65 only.

Mounting of External Operator GVAPH03 for Motor Circuit Breakers GV3L

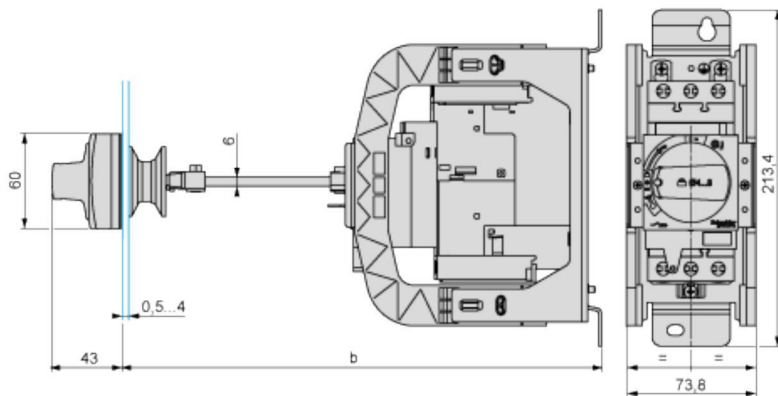

	b	
	Minimum	Maximum
GV3APN.. + GVAPH03	200	300
GV3APN.. + GVAPH03 + GVAPK12	300	492

Door cut-out

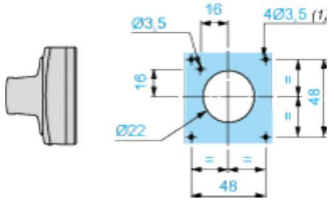

(1) For IP65 only.

GV3L••

